



solar

FIMINOX

SOLAR MOUNTING SYSTEM

quando s'incontrano
tecnologia e natura.



*when nature and
technology meet.*

*cuando la naturaleza y la
tecnología se encuentran.*

*wenn sich Natur
und Technik treffen.*

know-how



Fiminox, specializzata nei sistemi di fissaggio in Acciaio Inox, quali bulloneria, viteria, torneria, tiranteria, ecc..., mette a disposizione l'esperienza accumulata in decenni di operatività nel mercato dell'Acciaio Inox per fornire la propria linea di prodotti di fissaggio in INOX e ALLUMINIO dedicati all'industria del Solare e del Fotovoltaico e più in generale delle ENERGIE RINNOVABILI. Il nome della linea è SOLAR.



Il fissaggio proposto è in acciaio inox, materiale che presenta una altissima resistenza alla corrosione. L'accoppiamento con l'alluminio, leggero, indeformabile e di lunga durata, per sua natura diviene garanzia della lunga durata della struttura di sostegno dell'impianto fotovoltaico/solare.



Fiminox, specialized in stainless steel fastening systems, such as bolts, screws, turned components, rods, etc..., makes available the experience accumulated in decades of operation in the stainless steel market to provide our own product line of fixing products in STAINLESS STEEL and ALUMINIUM dedicated to the Solar and Photovoltaic industry and more generally to RENEWABLE ENERGIES. The line name is SOLAR.

The proposed fixing is in stainless steel, a material that has a very high resistance to corrosion.

The coupling with aluminum, light, non-deformable and long-lasting, by its nature becomes a guarantee of the long life of the support structure of the photovoltaic / solar system.



Fiminox, especializada en sistemas de fijación en acero inoxidable, tales como pernos, tornillos, tornos, varillas, etc..., pone a su disposición la experiencia acumulada en décadas de actuación en el mercado del acero inoxidable para proporcionar su propia línea de productos de fijación en ACERO INOXIDABLE y ALUMINIO dedicados a la industria Solar y Fotovoltaica y más en general a las ENERGÍAS RENOVABLES. El nombre de la línea es SOLAR.

La fijación propuesta es de acero inoxidable, un material que tiene una muy alta resistencia a la corrosión. El acoplamiento con aluminio, ligero, indeformable y duradero, por su naturaleza se convierte en garantía de la larga vida de la estructura soporte del sistema fotovoltaico/solar.



Fiminox, spezialisiert auf Edelstahl-Befestigungssysteme wie Bolzen, Schrauben, Drehteile, Stäbe usw., stellt die in jahrzehntelanger Tätigkeit auf dem Edelstahlmarkt gesammelte Erfahrung zur Verfügung, um eine eigene Produktlinie für Befestigungen aus EDELSTAHL und ALUMINIUM anzubieten für die Solar- und Photovoltaik-industrie und allgemein für ERNEUERBARE ENERGIEN. Der Liniename ist SOLAR.



Die vorgeschlagene Befestigung besteht aus Edelstahl, einem Material mit sehr hoher Korrosionsbeständigkeit. Die Verbindung mit Aluminium, leicht, nicht verformbar und langlebig, wird von Natur aus zu einer Garantie für die lange Lebensdauer der Tragstruktur der Photovoltaik- / Solaranlage





solar

elementi di fissaggio per pannelli solari e fotovoltaici
fastening system for solar and photovoltaic industry

 informazioni	 information	 Beschreibung
<p>DISTANZIALE "OMEGA"</p> <p><i>Descrizione</i> Distanziale universale</p> <p><i>Tipo installazione</i> Pannelli altezza minima 23mm</p> <p><i>Dimensioni</i> L60 X H23 Ø8</p> <p><i>Quantità min</i> 200</p> <p><i>Altre note</i> Alluminio</p>	<p>"OMEGA" SPACER</p> <p><i>Description</i> Universal spacer</p> <p><i>Installation type</i> Panels minimum height 23mm</p> <p><i>Dimensions</i> L60 X H23 Ø8</p> <p><i>Minimum quantity</i> 200</p> <p><i>Other notes</i> Aluminium</p>	<p>"OMEGA"-ABSTANDHALTER</p> <p><i>Beschreibung</i> Universal-Abstandhalter</p> <p><i>Installationstyp</i> Mindesthöhe der Paneele 23 mm</p> <p><i>Maße</i> L60 X H23 Ø8</p> <p><i>Mindestmenge</i> 200</p> <p><i>Weitere Hinweise</i> Aluminium</p>
<p>STAFFA "Z" TERMINALE</p> <p><i>Descrizione</i> Terminale per fissaggio pannello</p> <p><i>Tipo installazione</i> Pannelli altezza minima 25</p> <p><i>Dimensioni</i> 60 X H Ø8</p> <p><i>Quantità min</i> 200</p> <p><i>Altre note</i> Alluminio</p>	<p>TERMINAL "Z" BRACKET</p> <p><i>Description</i> Terminal for panel fixing</p> <p><i>Installation type</i> Panels minimum height 25</p> <p><i>Dimensions</i> 60 X H Ø8</p> <p><i>Minimum quantity</i> 200</p> <p><i>Other notes</i> Aluminium</p>	<p>KLEMME "Z"-HALTERUNG</p> <p><i>Beschreibung</i> Klemme für Plattenbefestigung</p> <p><i>Installationstyp</i> Mindesthöhe der Paneele 25</p> <p><i>Maße</i> 60 X H Ø8</p> <p><i>Mindestmenge</i> 200</p> <p><i>Weitere Hinweise</i> Aluminium</p>
<p>DISTANZIATORE "OMEGA" VETRO-VETRO</p> <p><i>Descrizione</i> Distanziatore universale per pannelli senza cornice</p> <p><i>Tipo installazione</i> Altezza minima pannelli 23mm</p> <p><i>Dimensioni</i> l x L Ø8</p> <p><i>Quantità min</i> 200</p> <p><i>Altre note</i> Alluminio</p>	<p>GLASS-GLASS "OMEGA" SPACER</p> <p><i>Description</i> Universal spacer for frameless panels</p> <p><i>Installation type</i> Panels minimum height 23mm</p> <p><i>Dimensions</i> l x L Ø8</p> <p><i>Minimum quantity</i> 200</p> <p><i>Other notes</i> Aluminium</p>	<p>GLAS-GLAS "OMEGA" DISTANZSTÜCK</p> <p><i>Beschreibung</i> Universalabstandhalter für rahmenlose Paneele</p> <p><i>Installationstyp</i> Minimale Plattenhöhe 23 mm</p> <p><i>Maße</i> l x L Ø8</p> <p><i>Mindestmenge</i> 200</p> <p><i>Weitere Hinweise</i> Aluminium</p>
<p>STAFFA "Z" VETRO-VETRO</p> <p><i>Descrizione</i> Terminale per fissaggio pannello senza cornice</p> <p><i>Tipo installazione</i> Altezza minima pannelli 25mm</p> <p><i>Dimensioni</i> l x L Ø8</p> <p><i>Quantità min</i> 200</p> <p><i>Altre note</i> Alluminio</p>	<p>GLASS-GLASS "Z" BRACKET</p> <p><i>Description</i> Terminal for fixing panel without frame</p> <p><i>Installation type</i> Panels minimum height 25</p> <p><i>Dimensions</i> l x L Ø8</p> <p><i>Minimum quantity</i> 200</p> <p><i>Other notes</i> Aluminium</p>	<p>GLAS-GLAS "Z" HALTERUNG</p> <p><i>Beschreibung</i> Klemme zur Befestigung von Paneelen ohne Rahmen</p> <p><i>Installationstyp</i> Minimale Plattenhöhe 25 mm</p> <p><i>Maße</i> l x L Ø8</p> <p><i>Mindestmenge</i> 200</p> <p><i>Weitere Hinweise</i> Aluminium</p>



fissaggio domestico

Partially integrated fixing system
Línea de montaje interno-parcialmente integrada
Halbintegrierte Solarbefestigungen

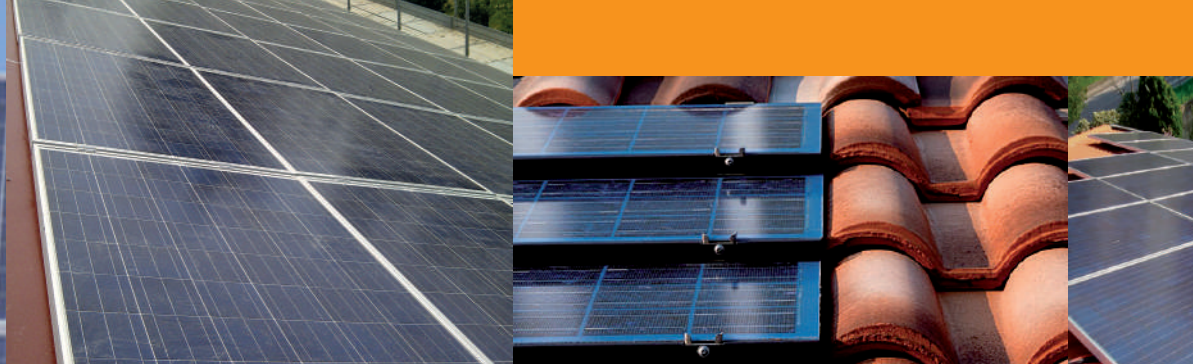

Linea di fissaggio domestico

Domestic fixing line • Línea de fijación doméstica • Hausbefestigungslinie



Elementi di fissaggio per pannelli solari e fotovoltaici su tetti con tegole. Il sistema di fissaggio è composto da: ACCESSORI di BULLONERIA: viti inox, dadi inox, hanger bolt inox.

SQUADRETTE e GANCI: squadrette inox o di alluminio, distanziali inox o di alluminio, ganci inox standardizzati o personalizzati su disegno del cliente.

PROFILATI di ALLUMINIO: standardizzati o personalizzati su disegno del cliente



Fixing elements for solar and photovoltaic panels on tiled roofs. The fixing system is composed of:

BOLTS ACCESSORIES:
stainless steel screws, stainless steel nuts, stainless steel hanger bolt.

BRACKETS and HOOKS:
stainless steel or aluminum brackets, stainless steel or aluminum spacers, standardized or customized stainless steel hooks according to the customer's design.

ALUMINUM PROFILES:
standardized or customized according to the customer's design.



Elementos de fijación de paneles solares y fotovoltaicos en cubiertas de tejas. El sistema de fijación se compone de:

ACCESORIOS PARA TORNILLOS:
tornillos de acero inoxidable, tuercas de acero inoxidable, perno de suspensión de acero inoxidable.

SOPORTES y GANCHOS:
soportes de acero inoxidable o aluminio, espaciadores de acero inoxidable o aluminio, ganchos de acero inoxidable estandarizados o personalizados según el diseño del cliente.

PERFILES DE ALUMINIO:
estandarizados o personalizados según diseño del cliente.



solar

elementi di fissaggio per pannelli solari e fotovoltaici
fastening system for solar and photovoltaic industry



informazioni



information



Beschreibung

"FIX"

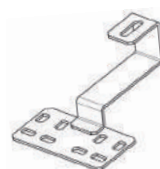

Descrizione
Staffa non regolabile
Tipo installazione
adatta a tetti a coppi
Dimensioni
150x50x5
Quantità min
100
Altre note
Acciaio Inox Aisi 304

Description
non adjustable bracket
Installation type
suited for roof tiles
Dimensions
150x50x5
Minimum quantity
100
Other notes
Stainless Steel Aisi 304

Beschreibung
Dachhaken NICHT verstellbar
Installationstyp
Ziegeldach
Maße
150x50x5
Mindestmenge
100
Weitere Hinweise
AISI 304

"S"

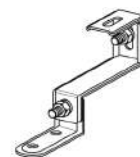

Descrizione
Staffa non regolabile
Tipo installazione
adatta a tetti a tegola piatta
Quantità min
100
Altre note
Acciaio Inox Aisi 304

Description
non adjustable bracket
Installation type
suited for flat roofs
Minimum quantity
100
Other notes
Stainless Steel Aisi 304

Beschreibung:
Dachhaken NICHT verstellbar
Installationstyp
Ziegeldach
Mindestmenge
100
Weitere Hinweise
AISI 304

"VARIO"

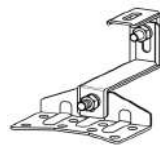

Descrizione
Staffa a doppia regolazione
Tipo installazione
adatta a tetti a coppi
Dimensioni
146x46x5
Quantità min
100
Altre note:
Acciaio Inox Aisi 304

Description
Double adjustment bracket
Installation type
suited for roof tiles
Dimensions
146x46x5
Minimum quantity
100
Other notes
Stainless Steel Aisi 304

Beschreibung
Verstellbare Dachhaken
Installationstyp
Ziegeldach
Maße
146x46x5
Mindestmenge
100
Weitere Hinweise
AISI 304



Befestigungselemente für Solar- und Photovoltaikmodule auf Ziegeldächern.

Das Befestigungssystem besteht aus:

BOLZEN ZUBEHÖR:

Edelstahlschrauben,
Edelstahlmuttern,
Edelstahlstockschraube.



HALTERUNGEN und HAKEN:





Halterungen aus Edelstahl oder Aluminium, Distanzstücke aus Edelstahl oder Aluminium, Standard-oder kundenspezifische Edelstahlhaken nach Kundenwunsch.



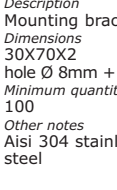



ALUMINIUMPROFILE:

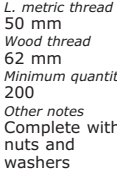
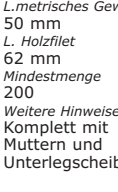

standardisiert oder individuell nach Kundenwunsch



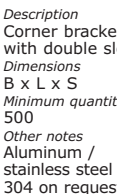









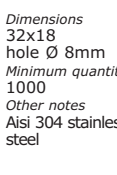

 informazioni	 information	 Beschreibung
STAFFA ADATTATRICE PER HANGERBOLT  <i>Descrizione</i> Staffa di fissaggio <i>Dimensioni</i> 30X70X2 foro Ø8mm + asola <i>Quantità min</i> 100 <i>Altre note</i> Inox Aisi 304	ADAPTER BRACKET FOR HANGERBOLT  <i>Description</i> Mounting bracket <i>Dimensions</i> 30X70X2 hole Ø 8mm + slot <i>Minimum quantity</i> 100 <i>Other notes</i> Aisi 304 stainless steel	ADAPTERHALTER FÜR STOCKSCHRAUBE  <i>Beschreibung</i> Montagehalterung <i>Maße</i> 30X70X2 Loch Ø 8mm + Langloch <i>Mindestmenge</i> 100 <i>Weitere Hinweise</i> Edelstahl AISI 304





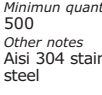

 informazioni	 information	 Beschreibung
HANGERBOLT M x L  <i>L. filetto metrico</i> 50 mm <i>L. filetto legno</i> 62 mm <i>Quantità min</i> 200 <i>Altre note</i> Completo di dadi e rondelle	HANGERBOLT M x L  <i>L. metric thread</i> 50 mm <i>L. wood thread</i> 62 mm <i>Minimum quantity</i> 200 <i>Other notes</i> Complete with nuts and washers	STOCKSCHRAUBEN M x L  <i>L. metrisches Gewinde</i> 50 mm <i>L. Holzfilet</i> 62 mm <i>Mindestmenge</i> 200 <i>Weitere Hinweise</i> Komplett mit Muttern und Unterlegscheiben





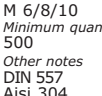

 informazioni	 information	 Beschreibung
STAFFA ASOLE  <i>Descrizione</i> Staffa angolare con doppia asola <i>Dimensioni</i> B x L x S <i>Quantità min</i> 500 <i>Altre note</i> Alluminio / Inox Aisi 304 su richiesta	BUTTONHOLE BRACKET  <i>Description</i> Corner bracket with double slot <i>Dimensions</i> B x L x S <i>Minimum quantity</i> 500 <i>Other notes</i> Aluminium / stainless steel Aisi 304 on request	KNOPFLOCHHALTER  <i>Beschreibung</i> Eckwinkel mit Doppelschlitz <i>Maße</i> B x L x S <i>Mindestmenge</i> 500 <i>Weitere Hinweise</i> Aluminium / Edelstahl AISI 304 auf Anfrage





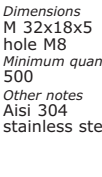

 informazioni	 information	 Beschreibung
VITE TESTA A MARTELLO 28/15  <i>Descrizione</i> Vite a martello per profili 28/15 <i>Dimensioni</i> M8 / M10 lung.da 20 a 70 mm <i>Quantità min</i> 500 <i>Altre note</i> Acciaio Inox Aisi 304	HAMMER HEAD SCREW 28/15  <i>Description</i> Hammer head screw for profiles 28/15 <i>Dimensions</i> M8 / M10 length from 20 to 70 mm <i>Minimum quantity</i> 500 <i>Other notes</i> Aisi 304 stainless steel	HAMMER-KOPFSCHRAUBE 28/15  <i>Beschreibung</i> Hammerkopfschraube für Profile 28/15 <i>Maße</i> M8 / M10 Länge von 20 bis 70 mm <i>Losgröße</i> 5000 <i>Mindestmenge</i> Edelstahl AISI 304



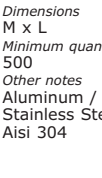

 informazioni	 information	 Beschreibung
DADO ROMBOIDALE  <i>Dimensioni</i> 32x18 foro Ø 8mm <i>Quantità min</i> 1000 <i>Altre note</i> Acciaio Inox Aisi 304	RHOMBUS NUT  <i>Dimensions</i> 32x18 hole Ø 8mm <i>Minimum quantity</i> 1000 <i>Other notes</i> Aisi 304 stainless steel	RAUTENMUTTER  <i>Maße</i> 32x18 Loch Ø 8mm <i>Mindestmenge</i> 1000 <i>Weitere Hinweise</i> Aisi 304

 informazioni	 information	 Beschreibung
DADO A STRAPPO  <i>Dimensioni</i> M 8/10 <i>Quantità min</i> 500 <i>Altre note</i> Acciaio Inox Aisi 304	SNAP NUT  <i>Dimensions</i> M 8/10 <i>Minimum quantity</i> 500 <i>Other notes</i> Aisi 304 stainless steel	SCHNAPPMUTTER  <i>Maße</i> M 8/10 <i>Mindestmenge</i> 500 <i>Weitere Hinweise</i> Edelstahl AISI 304

 informazioni	 information	 Beschreibung
DADO QUADRO  <i>Dimensioni</i> M 6/8/10 <i>Quantità min</i> 500 <i>Altre note</i> DIN 557 Acciaio Inox Aisi 304	SQUARE NUT  <i>Dimensions</i> M 6/8/10 <i>Minimum quantity</i> 500 <i>Other notes</i> DIN 557 Aisi 304 stainless steel	VIERKANTMUTTER  <i>Maße</i> M 6/8/10 <i>Mindestmenge</i> 500 <i>Weitere Hinweise</i> DIN 557 Edelstahl AISI 304

 informazioni	 information	 Beschreibung
DADO ROMBOIDALE  <i>Dimensioni</i> M 32x18x5 con foro M8 <i>Quantità min</i> 500 <i>Altre note</i> Acciaio Inox Aisi 304	RHOMBUS NUT  <i>Dimensions</i> M 32x18x5 with hole M8 <i>Minimum quantity</i> 500 <i>Other notes</i> Aisi 304 stainless steel	RAUTENMUTTER  <i>Maße</i> M 32x18x5 mit Bohrung M8 <i>Mindestmenge</i> 500 <i>Weitere Hinweise</i> Edelstahl AISI 304



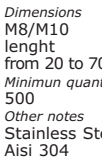
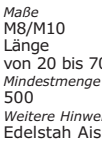

 informazioni	 information	 Beschreibung
RIVETTO TENUTA STAGNA  <i>Dimensioni</i> M x L <i>Quantità min</i> 500 <i>Altre note</i> Alluminio / Inox Aisi 304	WATERPROOF RIVET  <i>Dimensions</i> M x L <i>Minimum quantity</i> 500 <i>Other notes</i> Aluminum / Stainless Steel Aisi 304	WASSERDICHE NIET  <i>Maße</i> M x L <i>Losgröße</i> 500 <i>Weitere Hinweise</i> Aluminium / Edelstahl Aisi 304





 informazioni	 information	 Beschreibung
VITE A STRAPPO DI SICUREZZA  <i>Dimensioni</i> M8/M10 lung. da 20 a 70 mm <i>Quantità min</i> 500 <i>Altre note</i> Inox Aisi 304	SAFETY SNAP SCREW  <i>Dimensions</i> M8/M10 length from 20 to 70 mm <i>Minimum quantity</i> 500 <i>Other notes</i> Stainless Steel Aisi 304	SICHERHEITSSCHNAPPSCHRAUBE  <i>Maße</i> M8/M10 Länge von 20 bis 70 mm <i>Mindestmenge</i> 500 <i>Weitere Hinweise</i> Edelstahl Aisi 304

accessori acciaio inox di fissaggio



Stainless Steel fixing accessories • Befestigungszubehöre aus Edelstahl



 informazioni	 information	 Beschreibung
VITE DIN 933  <i>Descrizione</i> Viti a testa esagonale tutto filetto <i>Dimensioni</i> M8/M10/M12 lunghezze da 20 a 100 <i>Quantità min</i> 100 <i>Altre note</i> AISI 304, AISI 316 70, AISI 316 80	SCREW DIN 933 <i>Description</i> Hexagonal Head Screws Full thread <i>Dimensions</i> M8/M10/M12 length from 20 to 100 <i>Minimum quantity</i> 100 <i>Other notes</i> AISI 304, SIDI 316 70, AISI 316 80	SCHRAUBEN DIN 933 <i>Beschreibung</i> Sechskantschrauben ohne Schaft <i>Maße</i> M6/M8/M10/M12 Länge von 20 bis 100 <i>Mindestmenge</i> 100 <i>Weitere Hinweise</i> AISI 304, AISI 316 70, AISI 316 80

 informazioni	 information	 Beschreibung
VITE DIN 931  <i>Descrizione</i> Viti a testa esagonale parziale filetto <i>Dimensioni</i> M8/M10/M12 lunghezze da 20 a 100 <i>Quantità min</i> 100 <i>Altre note</i> AISI 304, AISI 316 70, AISI 316 80	SCREW DIN 931 <i>Description</i> Hexagonal Head Screws Partial thread <i>Dimensions</i> M8/M10/M12 length from 20 to 100 <i>Minimum quantity</i> 100 <i>Other notes</i> AISI 304, SIDI 316 70, AISI 316 80	SCHRAUBEN DIN 931 <i>Beschreibung</i> Sechskantschrauben mit schaft <i>Maße</i> M8/M10/M12 Länge von 20 bis 100 <i>Mindestmenge</i> 100 <i>Weitere Hinweise</i> AISI 304, AISI 316 70, AISI 316 80





 informazioni	 information	 Beschreibung
VITE DIN 912  <i>Descrizione</i> Viti con cava esagonale, testa cilindrica <i>Dimensioni</i> M8/M10/M12 lunghezze da 20 a 100 <i>Quantità min</i> 100 <i>Altre note</i> AISI 304, AISI 316 70, AISI 316 80	SCREW DIN 912 <i>Description</i> Hexagon Socket head cap screw <i>Dimensions</i> M8/M10/M12 length from 20 to 100 <i>Minimum quantity</i> 100 <i>Other notes</i> AISI 304, SIDI 316 70, AISI 316 80	SCHRAUBEN DIN 912 <i>Beschreibung</i> Zylinderschrauben mit Innensechskant <i>Maße</i> M6/M8/M10/M12 Länge von 20 bis 100 <i>Mindestmenge</i> 100 <i>Weitere Hinweise</i> AISI 304, AISI 316 70, AISI 316 80





 informazioni	 information	 Beschreibung
VITE DIN 571  <i>Descrizione</i> Viti con testa esagonale e filetto a legno <i>Dimensioni</i> M8/M10/M12 lunghezze da 20 a 100 <i>Quantità min</i> 100 <i>Altre note</i> AISI 304, AISI 316 70, AISI 316 80	SCREW DIN 571 <i>Description</i> Hexagonal Head Screws and wood thread <i>Dimensions</i> M8/M10/M12 length from 20 to 100 <i>Minimum quantity</i> 100 <i>Other notes</i> AISI 304, SIDI 316 70, AISI 316 80	SCHRAUBEN DIN 571 <i>Beschreibung</i> Sechskant-Holzschrauben <i>Maße</i> M6/M8/M10/M12 Länge von 20 bis 100 <i>Mindestmenge</i> 100 <i>Weitere Hinweise</i> AISI 304, AISI 316 70, AISI 316 80

 informazioni	 information	 Beschreibung
VITE DIN 603  <i>Descrizione:</i> Bulloni a testa tonda larga con quadro sottotesta <i>Dimensioni:</i> M8/M10/M12 lunghezze da 20 a 100 <i>Quantità min</i> 100 <i>Altre note</i> AISI 304, AISI 316 70, AISI 316 80	SCREW DIN 603 <i>Description</i> Mushroom head screw with square neck <i>Dimensions</i> M8/M10/M12 length from 20 to 100 <i>Minimum quantity</i> 100 <i>Other notes</i> AISI 304, SIDI 316 70, AISI 316 80	SCHRAUBEN DIN 603 <i>Beschreibung:</i> Flachrundschrauben mit Vierkantansatz <i>Maße</i> M6/M8/M10/M12 Länge von 20 bis 100 <i>Mindestmenge</i> 100 <i>Weitere Hinweise</i> AISI 304, AISI 316 70, AISI 316 80





 informazioni	 information	 Beschreibung
RONDELLE DI GUARNIZIONE  <i>Descrizione</i> Rondelle di guarnizione per hangerbolts colore nero <i>Dimensioni</i> M8 / M10 <i>Quantità min</i> 1000 <i>Altre note</i> EPDM	GASKET WASHERS <i>Description</i> Black Gasket washers for hangerbolts <i>Dimensions</i> M8/M10 <i>Minimum quantity</i> 1000 <i>Other notes</i> EPDM	DICHTSCHEIBEN <i>Beschreibung:</i> Schwarze Dichtungen fuer Stockschrauben <i>Maße</i> M8/M10 <i>Mindestmenge</i> 1000 <i>Weitere Hinweise</i> EPDM





 informazioni	 information	 Beschreibung
RONDELLE DIN 125  <i>Dimensioni</i> M8/M10/M12 <i>Quantità min</i> 1000 <i>Altre note</i> Acciaio Inox Aisi 304	DIN 125 WASHERS <i>Dimensions</i> M8/M10/M12 <i>Minimum quantity</i> 1000 <i>Material</i> Stainless Steel Aisi 304	SCHLEIBEN DIN 125 <i>Beschreibung</i> Flach Scheiben ohne Fase <i>Maße</i> M8/M10/M12 <i>Mindestmenge</i> 1000 <i>Weitere Hinweise</i> Acciaio Inox Aisi 304

 informazioni	 information	 Beschreibung
RONDELLE DIN 127  <i>Dimensioni</i> M8/M10/M12 <i>Quantità min</i> 1000 <i>Altre note</i> Acciaio Inox Aisi 304	DIN 127 WASHERS <i>Dimensions</i> M8/M10/M12 <i>Minimum quantity</i> 1000 <i>Other notes</i> Stainless Steel Aisi 304	SCHLEIBEN DIN 127 <i>Beschreibung</i> Federringe FORM A oder B <i>Maße</i> M8/M10/M12 <i>Mindestmenge</i> 1000 <i>Weitere Hinweise</i> Aisi 304

 informazioni	 information	 Beschreibung
RONDELLE DI SICUREZZA "S"  <i>Descrizione</i> Rondella di sicurezza zigrinata "S" <i>Dimensioni</i> M8/M10/M12 <i>Quantità min</i> 1000 <i>Altre note</i> Aisi 304	"S" SECURITY WASHERS <i>Description</i> Security washers with "S" serration <i>Dimension</i> M8/M10/M12 <i>Minimum quantity</i> 1000 <i>Other notes</i> Aisi 304	SICHERUNGSSCHLEIBEN "S" <i>Beschreibung</i> Federringe FORM A oder B <i>Maße</i> M8/M10/M12 <i>Mindestmenge</i> 1000 <i>Weitere Hinweise</i> Aisi 304

 informazioni	 information	 Beschreibung
DADI DI SICUREZZA DIN 6923  <i>Descrizione</i> Dadi flangiati zigrinati di sicurezza <i>Dimensioni</i> M8/M10/M12 <i>Quantità min</i> 1000 <i>Altre note</i> Aisi 304	SECURITY NUTS DIN 6923 <i>Description</i> Security Hexagonal Flange Nuts <i>Dimension</i> M8/M10/M12 <i>Minimum quantity</i> 1000 <i>Other notes</i> Aisi 304	MUTTERN DIN 6923 <i>Beschreibung</i> Sicherungsmutter nmit Flansch und Sperrverzahnung <i>Maße</i> M8/M10/M12 <i>Mindestmenge</i> 1000 <i>Weitere Hinweise</i> Aisi 304

 informazioni	 information	 Beschreibung
DADI DIN 934  <i>Dimensioni</i> M8/M10/M12 <i>Quantità min</i> 1000 <i>Altre note</i> Acciaio Inox Aisi 304	NUTS DIN 934 <i>Dimensions</i> M8/M10/M12 <i>Minimum quantity</i> 1000 <i>Other notes</i> Stainless Steel Aisi 304	MUTTERN DIN 934 <i>Beschreibung</i> Sechskantmuttern <i>Maße</i> M8/M10/M12 <i>Mindestmenge</i> 1000 <i>Weitere Hinweise</i> Aisi 304

 informazioni	 information	 Beschreibung
DADI QUADRI DIN 557  <i>Dimensioni</i> M8/M10/M12 <i>Quantità min</i> 1000 <i>Altre note</i> Acciaio Inox Aisi 304	SQUARE NUTS DIN 557 <i>Dimensions</i> M8/M10/M12 <i>Minimum quantity</i> 1000 <i>Other notes</i> Stainless Steel Aisi 304	MUTTERN DIN 557 <i>Beschreibung</i> Vierkanmuttern <i>Maße</i> M8/M10/M12 <i>Mindestmenge</i> 1000 <i>Weitere Hinweise</i> Aisi 304

fissaggio industriale

Partially integrated fixing system for industrial rooftops
Línea de montaje parcialmente integrada para techos industriales
Halbintegrierte Solarbefestigungen für industrielle Flachdächern



Linea di fissaggio industriale

Industrial fixing line • Línea de fijación industrial • Industrielle Befestigungslinie



Strutture ed elementi di fissaggio per pannelli su tetti industriali, piani, inclinati o curvi.

Il sistema prevede sei fissaggi standard ed elementi custom progettati sulla base del layout di posa e della copertura esistente:
ACCESSORI di BULLONERIA: viti inox, dadi inox, hangerbolts inox;
SQUADRETTE E GANCI: squadrette inox, distanziali inox, ganci custom

PROFILATI di ALLUMINIO:

Profili estrusi standard o personalizzati su disegno del cliente.



Structures and fasteners for panels on industrial, flat, sloping or curved roofs.

The system includes six standard fixings and custom elements designed on the basis of the installation layout and the existing roof:

BOLTS ACCESSORIES:

stainless steel screws,
stainless steel nuts, stainless
steel hangerbolts

BRACKETS AND HOOKS:

stainless steel brackets,
stainless steel spacers,
custom hooks

ALUMINUM PROFILES

Standard or customized
extruded profiles based on
the customer's design



Estructuras y fijaciones para paneles en cubiertas industriales, planas, inclinadas o curvas.

El sistema incluye seis fijaciones estándar y elementos personalizados diseñados en base al esquema de instalación y al techo existente

ACCESORIOS PARA PERNOS:
tornillos de acero inoxidable,
tuercas de acero inoxidable,
pernos de suspensión de acero
inoxidable

SOPORTES y GANCHOS:
soportes de acero inoxidable,
espaciadores de acero inoxidable,
ganchos personalizados.

PERFILES DE ALUMINIO:
Perfiles extrusionados estándar
o personalizados según diseño
del cliente.





solar

elementi di fissaggio per pannelli solari e fotovoltaici
fastening system for solar and photovoltaic industry

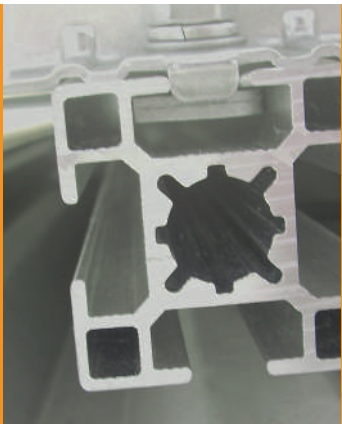

Strukturen und Befestigungen für Paneele auf Industrie-, Flach-, Schräg- oder Runddächern.

Das System umfasst sechs Standardbefestigungen und kundenspezifische Elemente, die auf der Grundlage des Installationslayouts und des vorhandenen Dachs entworfen wurden:

SCHRAUBENZUBEHÖR

Edelstahlschrauben, Edelstahlmuttern, Edelstahl-Stockschrauben;

HALTERUNGEN und HAKEN:

Edelstahlhalterungen, Edelstahlabstandshalter, kundenspezifische Haken

ALUMINIUMPROFILE:

Standard- oder kundenspezifische Strangpressprofile nach Kundenwunsch



informazioni

PROFILATI ALLUMINIO 40x40 L6000"

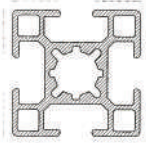

Descrizione
Profilato di Alluminio a disegno
Dimensioni
40x40x6000
Quantità min
20
Altre note
Alluminio



information

ALUMINIUM SECTIONS 40X40 L6000

Description
Aluminium sections on drawing
Dimensions
40x40x6000
Minimum quantity
20
Other notes
Aluminium



Beschreibung

ALUMINIUM PROFILE 40X40 L6000

Beschreibung
Aluminium Profile nach Zeichnung
Maße
40x40x6000
Mindestmenge
20
Weitere Hinweise
Aluminium

PROFILO A "C" CON ALETTE



Dimensioni
93x20,5x3,5
Barre/Spezioni
cm 30
Quantità
Su richiesta
Altre note
Alluminio

"C" PROFILE WITH FINS

Dimensions
93x20,5x3,5
Bars/pieces
30 cm
Amount
On request
Other notes
Aluminium

"C"-PROFIL MIT FINNEN

Maße
93x20,5x3,5
Stangen/Stücke
30 cm
Menge
Auf Anfrage
Weitere Hinweise
Aluminium

ESTRUSO 90X70



Descrizione
Profilato di Alluminio a disegno
Dimensioni
90x70x6000
Quantità min
20
Altre note
Alluminio

EXTRUDED 90X70

Description
Aluminium sections on drawing
Dimensions
90x70x6000
Minimum quantity
20
Other notes
Aluminium

EXTRUDIERTE 90X70

Beschreibung
Aluminium Profile nach Zeichnung
Maße
90x70x6000
Mindestmenge
20
Weitere Hinweise
Aluminium



strutture a vela

Sail type structure
Estructura tipo vela
Struktur vom Typ Segel



Linea di fissaggio per campi e pensiline fotovoltaiche

Fixing line for photovoltaic fields and canopies

Línea de fijación para campos fotovoltaicos y marquesinas

Befestigungslinie für Photovoltaikfelder und Überdachungen



Strutture per campi fotovoltaici, monopalo e bipalo standard e custom.
Pensiline parcheggio modulari, e/o ripristino di strutture esistenti per adattamento a pensiline fotovoltaiche.



Structures for photovoltaic fields, standard and custom single and double poles.
Modular parking shelters, and / or restoration of existing structures for adaptation to photovoltaic shelters.



Estructuras para campos fotovoltaicos, postes simples y dobles estándar y personalizados.
Aparcamientos modulares de marquesinas, y/o rehabilitación de estructuras existentes para su adaptación a marquesinas fotovoltaicas.

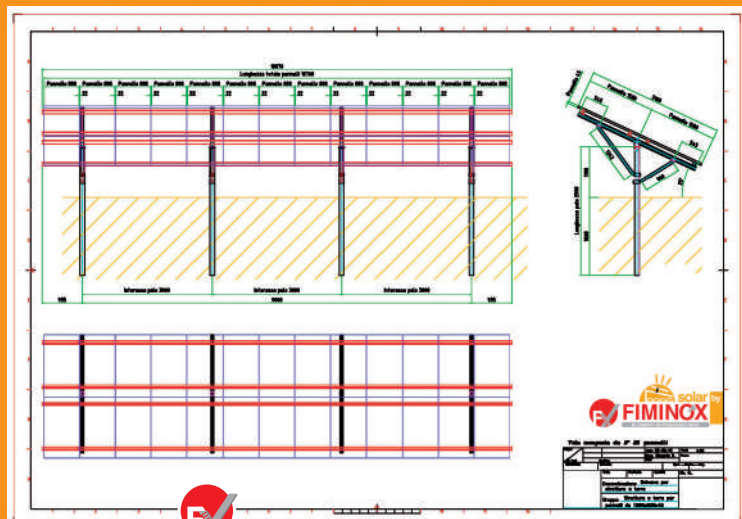

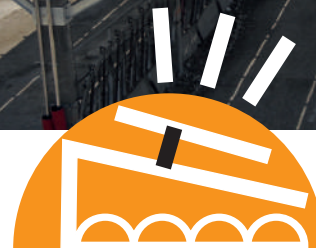
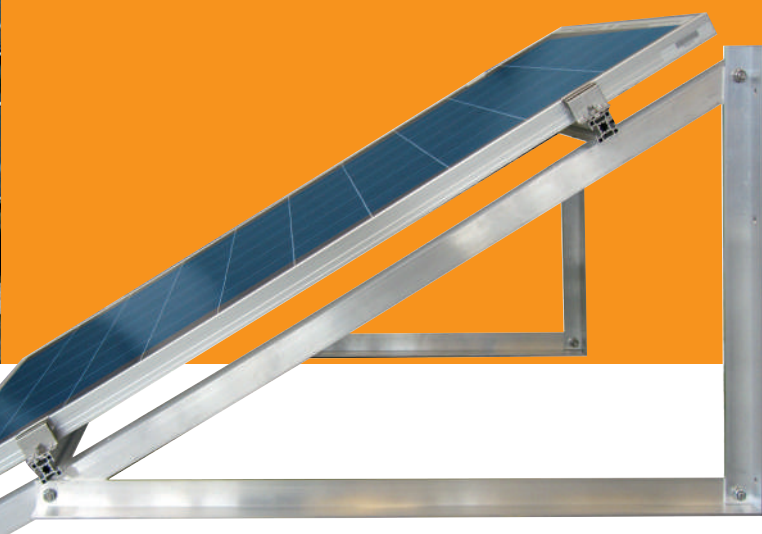

solar

elementi di fissaggio per pannelli solari e fotovoltaici
fastening system for solar and photovoltaic industry



 **Strukturen für Photovoltaikfelder, Standard- und kundenspezifische Einzel- und Doppelmasten. Modulare Parküberdachungen und / oder Restaurierung bestehender Strukturen zur Anpassung an Photovoltaiküberdachungen.**

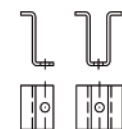

elementi "zeta e omega" per fissaggio dei moduli ai profili di alluminio

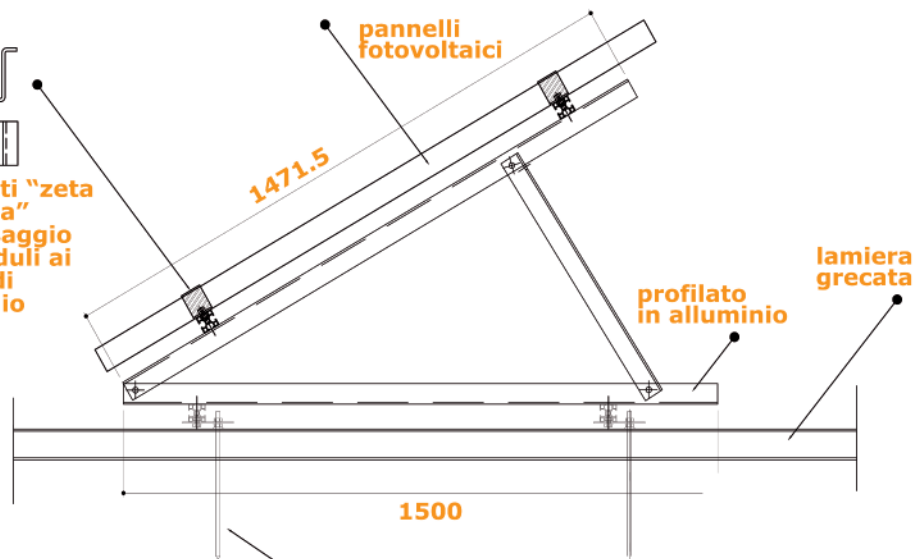

viti di ancoraggio con guarnizione in EPDM



informazioni

CAVALLETTO ALLUMINIO per TETTI PIANI

Descrizione
Struttura triangolare per tetti piani

Dimensioni
Angolare 40x40 preforato c/kit assemblaggio

Quantità min
100

Altre note
Alluminio



information

ALUMINIUM SUPPORT FOR FLAT ROOF

Description
Triangular structure for flat roofs

Dimensions
Angular 40x40 pre-punched w/ assembling kit

Minimum quantity
100

Other notes
Aluminium



Beschreibung

ALU-BAUGEFÜGE FÜR FLACHDÄCHER

Beschreibung
dreieckige Struktur für Flachdächer

Maße
angular 40x40 pre-montiert mit montage kit

Mindestmenge
100

Weitere Hinweise
Aluminium



La garanzia di un servizio, la qualità di un prodotto, la forza di esserci... sempre.



The guarantee of service, the quality of a product, the force of being present... always!



¡La garantía de un servicio, la calidad de un producto, la fuerza de estar...siempre!



Die Garantie Für Service, die Qualität eines Produkts, die Kraft immer Anwesend zu sein!



FIMINOX

SOLAR MOUNTING SYSTEM

Fiminox S.p.A.
via per Carpiano, 18
20077 Melegnano (Mi) Italy
+39.02.98033501 +39.02.98033502
info@fiminox.com - www.fiminox.com